

Data sheet | Item number: 769-667

THT male header; 1.0 x 1.0 mm solder pin; angled; Pin spacing 5 mm; 7-pole



769-667



RoHS Compliant

[BOMcheck.net](https://www.bomcheck.net)

Color: ■

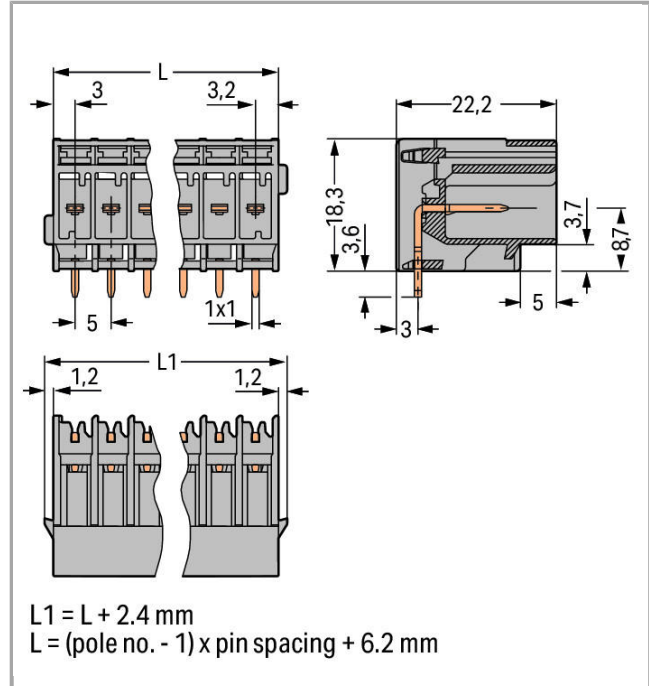

Data

Electrical data

Ratings per IEC/EN 60664-1

Rated voltage (III / 3)	250 V
Rated impulse voltage (III / 3)	4 kV
Rated voltage (III / 2)	500 V
Rated impulse voltage (III / 2)	4 kV
Rated current	32 A

Connection data

No. of poles	7
Total number of potentials	7
Number of levels	1

Geometrical Data

Pin spacing	5 mm / 0.197 inch
Width	38.6 mm / 1.52 inch
Height from the surface	18.3 mm / 0.72 inch
Depth	22.2 mm / 0.874 inch

Plug connection

Contact type (pluggable connector)	Male connector/plug
Connector connection type	for PCBs
Mismating protection	No
Mating direction to the PCB	0°

PCB contact

PCB contact	THT
-------------	-----

Material Data

Color	gray
Insulating material	Polyamide 66 (PA 66)
Fire load	0.158 MJ
Weight	7.801 g

Commercial data

Product Group	18 (X-COM-System)
Country of origin	DE
GTIN	4044918760416
Customs Tariff No.	85366990990

Approvals / Certificates

Country specific Approvals

Logo	Approval	Additional Approval Text	Certificate name
	CCA DEKRA Certification B.V.	EN 60947	NTR NL-7626
	CCA DEKRA Certification B.V.	EN 61984	2190419.02
	CCA	IEC 61984	NL-47799

DEKRA Certification B.V.



CSA
DEKRA Certification B.V.

C22.2 No. 158

1101144





KEMA/KEUR
DEKRA Certification B.V.

EN 60947

2190419.01

UL-Approvals





Logo	Approval	Additional Approval Text	Certificate name
	UR Underwriters Laboratories Inc.	UL 1977	E45171
	UR Underwriters Laboratories Inc.	UL 1059	E45172















Compatible products















Coding















	Item no.: 769-435 Coding pin; for coding of female plugs; for carrier terminal blocks / male connectors	769-435
--	--	---------

Female plug

	Item no.: 769-101 1-conductor female plug; 4 mm ² ; 1-pole	769-101
	Item no.: 769-102 1-conductor female plug; 4 mm ² ; 2-pole	769-102
	Item no.: 769-102/000-036 1-conductor female plug; 4 mm ² ; 2-pole	769-102 /000-036
	Item no.: 769-102/000-037 1-conductor female plug; 4 mm ² ; 2-pole	769-102 /000-037
	Item no.: 769-103 1-conductor female plug; 4 mm ² ; 3-pole	769-103

	Item no.: 769-103/000-036 1-conductor female plug; 4 mm²; 3-pole	769-103 /000-036
	Item no.: 769-103/000-037 1-conductor female plug; 4 mm²; 3-pole	769-103 /000-037
	Item no.: 769-103/000-038 1-conductor female plug; 4 mm²; 3-pole	769-103 /000-038
	Item no.: 769-103/000-039 1-conductor female plug; 4 mm²; 3-pole	769-103 /000-039
	Item no.: 769-104 1-conductor female plug; 4 mm²; 4-pole	769-104
	Item no.: 769-104/000-036 1-conductor female plug; 4 mm²; 4-pole	769-104 /000-036
	Item no.: 769-104/000-037 1-conductor female plug; 4 mm²; 4-pole	769-104 /000-037
	Item no.: 769-104/000-038 1-conductor female plug; 4 mm²; 4-pole	769-104 /000-038
	Item no.: 769-104/000-039 1-conductor female plug; 4 mm²; 4-pole	769-104 /000-039
	Item no.: 769-105 1-conductor female plug; 4 mm²; 5-pole	769-105
	Item no.: 769-105/000-036 1-conductor female plug; 4 mm²; 5-pole	769-105 /000-036
	Item no.: 769-105/000-037 1-conductor female plug; 4 mm²; 5-pole	769-105 /000-037
	Item no.: 769-105/000-038 1-conductor female plug; 4 mm²; 5-pole	769-105 /000-038
	Item no.: 769-105/000-039 1-conductor female plug; 4 mm²; 5-pole	769-105 /000-039
	Item no.: 769-106 1-conductor female plug; 4 mm²; 6-pole	769-106

	Item no.: 769-106/000-006 1-conductor female plug; 4 mm ² ; 6-pole	769-106 /000-006
	Item no.: 769-106/000-036 1-conductor female plug; 4 mm ² ; 6-pole	769-106 /000-036
	Item no.: 769-106/000-037 1-conductor female plug; 4 mm ² ; 6-pole	769-106 /000-037
	Item no.: 769-106/000-038 1-conductor female plug; 4 mm ² ; 6-pole	769-106 /000-038
	Item no.: 769-106/000-039 1-conductor female plug; 4 mm ² ; 6-pole	769-106 /000-039
	Item no.: 769-107 1-conductor female plug; 4 mm ² ; 7-pole	769-107
	Item no.: 769-107/000-036 1-conductor female plug; 4 mm ² ; 7-pole	769-107 /000-036
	Item no.: 769-107/000-037 1-conductor female plug; 4 mm ² ; 7-pole	769-107 /000-037
	Item no.: 769-107/000-038 1-conductor female plug; 4 mm ² ; 7-pole	769-107 /000-038
	Item no.: 769-107/000-039 1-conductor female plug; 4 mm ² ; 7-pole	769-107 /000-039
	Item no.: 769-107/021-000 1-conductor female plug; Locking lever; 4 mm ² ; 7-pole	769-107 /021-000
	Item no.: 769-108 1-conductor female plug; 4 mm ² ; 8-pole	769-108
	Item no.: 769-108/000-036 1-conductor female plug; 4 mm ² ; 8-pole	769-108 /000-036
	Item no.: 769-108/000-037 1-conductor female plug; 4 mm ² ; 8-pole	769-108 /000-037
	Item no.: 769-108/000-038 1-conductor female plug; 4 mm ² ; 8-pole	769-108 /000-038

	Item no.: 769-108/000-039 1-conductor female plug; 4 mm ² ; 8-pole	/000-039	769-108
	Item no.: 769-109 1-conductor female plug; 4 mm ² ; 9-pole		769-109
	Item no.: 769-109/000-036 1-conductor female plug; 4 mm ² ; 9-pole	/000-036	769-109
	Item no.: 769-109/000-037 1-conductor female plug; 4 mm ² ; 9-pole	/000-037	769-109
	Item no.: 769-109/000-038 1-conductor female plug; 4 mm ² ; 9-pole	/000-038	769-109
	Item no.: 769-109/000-039 1-conductor female plug; 4 mm ² ; 9-pole	/000-039	769-109
	Item no.: 769-110 1-conductor female plug; 4 mm ² ; 10-pole		769-110
	Item no.: 769-110/000-036 1-conductor female plug; 4 mm ² ; 10-pole	/000-036	769-110
	Item no.: 769-110/000-037 1-conductor female plug; 4 mm ² ; 10-pole	/000-037	769-110
	Item no.: 769-110/000-038 1-conductor female plug; 4 mm ² ; 10-pole	/000-038	769-110
	Item no.: 769-110/000-039 1-conductor female plug; 4 mm ² ; 10-pole	/000-039	769-110
	Item no.: 769-111 1-conductor female plug; 4 mm ² ; 11-pole		769-111
	Item no.: 769-111/000-036 1-conductor female plug; 4 mm ² ; 11-pole	/000-036	769-111
	Item no.: 769-111/000-037 1-conductor female plug; 4 mm ² ; 11-pole	/000-037	769-111
	Item no.: 769-111/000-038 1-conductor female plug; 4 mm ² ; 11-pole	/000-038	769-111
	Item no.: 769-111/000-039 1-conductor female plug; 4 mm ² ; 11-pole	/000-039	769-111

**Item no.: 769-112**1-conductor female plug; 4 mm²; 12-pole

769-112

Item no.: 769-112/000-0361-conductor female plug; 4 mm²; 12-pole

/000-036

769-112

Item no.: 769-112/000-0371-conductor female plug; 4 mm²; 12-pole

/000-037

769-112

Item no.: 769-112/000-0381-conductor female plug; 4 mm²; 12-pole

/000-038

769-112

Item no.: 769-112/000-0391-conductor female plug; 4 mm²; 12-pole

/000-039

769-112

Item no.: 769-1131-conductor female plug; 4 mm²; 13-pole

769-113

Item no.: 769-113/000-0361-conductor female plug; 4 mm²; 13-pole

/000-036

769-113

Item no.: 769-113/000-0371-conductor female plug; 4 mm²; 13-pole

/000-037

769-113

Item no.: 769-113/000-0381-conductor female plug; 4 mm²; 13-pole

/000-038

769-113

Item no.: 769-113/000-0391-conductor female plug; 4 mm²; 13-pole

/000-039

769-113

Item no.: 769-1141-conductor female plug; 4 mm²; 14-pole

769-114

Item no.: 769-114/000-0361-conductor female plug; 4 mm²; 14-pole

/000-036

769-114

Item no.: 769-114/000-0371-conductor female plug; 4 mm²; 14-pole

/000-037

769-114

Item no.: 769-114/000-0381-conductor female plug; 4 mm²; 14-pole



















/000-038

769-114

Item no.: 769-114/000-0391-conductor female plug; 4 mm²; 14-pole

/000-039

769-114

	Item no.: 769-115 1-conductor female plug; 4 mm ² ; 15-pole	769-115
	Item no.: 769-115/000-036 1-conductor female plug; 4 mm ² ; 15-pole	769-115 /000-036
	Item no.: 769-115/000-037 1-conductor female plug; 4 mm ² ; 15-pole	769-115 /000-037
	Item no.: 769-115/000-038 1-conductor female plug; 4 mm ² ; 15-pole	769-115 /000-038
	Item no.: 769-115/000-039 1-conductor female plug; 4 mm ² ; 15-pole	769-115 /000-039
	Item no.: 769-122 2-conductor female connector; 4 mm ² ; 2-pole	769-122
	Item no.: 769-123 2-conductor female connector; 4 mm ² ; 3-pole	769-123
	Item no.: 769-124 2-conductor female connector; 4 mm ² ; 4-pole	769-124
	Item no.: 769-125 2-conductor female connector; 4 mm ² ; 5-pole	769-125
	Item no.: 769-126 2-conductor female connector; 4 mm ² ; 6-pole	769-126
	Item no.: 769-127 2-conductor female connector; 4 mm ² ; 7-pole	769-127
	Item no.: 769-128 2-conductor female connector; 4 mm ² ; 8-pole	769-128
	Item no.: 769-129 2-conductor female connector; 4 mm ² ; 9-pole	769-129
	Item no.: 769-130 2-conductor female connector; 4 mm ² ; 10-pole	769-130
	Item no.: 769-131 2-conductor female connector; 4 mm ² ; 11-pole	769-131
	Item no.: 769-132 2-conductor female connector; 4 mm ² ; 12-pole	769-132
	Item no.: 769-133 2-conductor female connector; 4 mm ² ; 13-pole	769-133
	Item no.: 769-134 2-conductor female connector; 4 mm ² ; 14-pole	769-134



Item no.: 769-135
2-conductor female connector; 4 mm²; 15-pole

769-135

ferrule

Item no.: 216-101
Ferrule; Sleeve for 0.5 mm² / AWG 22; uninsulated; electro-tin plated

216-101



Item no.: 216-102
Ferrule; Sleeve for 0.75 mm² / AWG 20; uninsulated; electro-tin plated

216-102



Item no.: 216-103
Ferrule; Sleeve for 1 mm² / AWG 18; uninsulated; electro-tin plated

216-103



Item no.: 216-104
Ferrule; Sleeve for 1.5 mm² / AWG 16; uninsulated; electro-tin plated

216-104



Item no.: 216-201
Ferrule; Sleeve for 0.5 mm² / 20 AWG; insulated; electro-tin plated

216-201



Item no.: 216-202
Ferrule; Sleeve for 0.75 mm² / 18 AWG; insulated; electro-tin plated

216-202



Item no.: 216-203
Ferrule; Sleeve for 1 mm² / AWG 18; insulated; electro-tin plated

216-203



Item no.: 216-204
Ferrule; Sleeve for 1.5 mm² / AWG 16; insulated; electro-tin plated

216-204



Item no.: 216-206
Ferrule; Sleeve for 2.5 mm² / AWG 14; insulated; electro-tin plated

216-206

Item no.: 216-301
Ferrule; Sleeve for 0.25 mm² / AWG 24; insulated; electro-tin plated

216-301



Item no.: 216-302
Ferrule; Sleeve for 0.34 mm² / 22 AWG; insulated; electro-tin plated

216-302

Marking accessories

Item no.: 210-831
Marking strips; on reel; 2.3 mm wide; plain; Self-adhesive

210-831



Item no.: 210-832
Marking strips; on reel; 3 mm wide; plain; Self-adhesive

210-832



Item no.: 210-833
Marking strips; on reel; 6 mm wide; plain; Self-adhesive

210-833



Item no.: 210-834
Marking strips; on reel; 5 mm wide; plain; Self-adhesive

210-834

Downloads
Documentation**Bid Text**

769-667

doc
25.6 kB

Download



CAD/CAE - Smart Data

CAD data

3D Download 769-667

URL

Download

Product family

X-COM

[Learn more about the product family.](#)

[Show all products from the family](#)

Subject to changes.
